

**Please, read this manual
carefully before use!**

User Manual



Cordless chain saw

KS MCS20V-12
KS MCS20V-12 Set

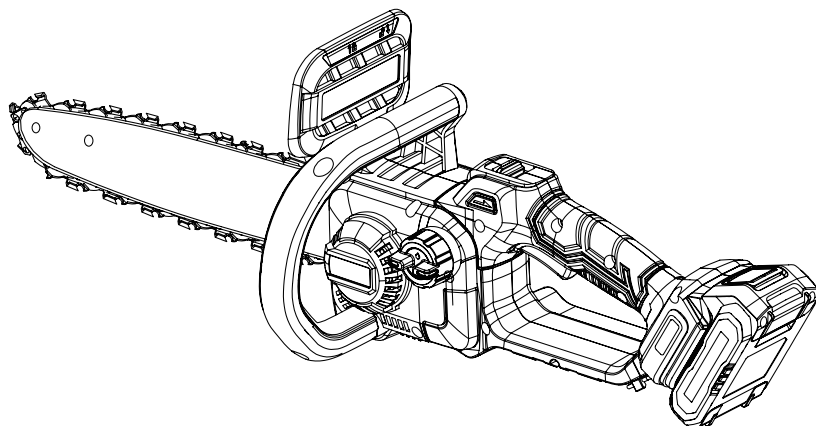



Thank you for choosing **Könnér & Söhnen®** products. This manual contains a brief description of safety, setup and use. More information can be found on the official importer's website in the support section: **konner-sohnen.com/pages/instructions**

You can also go to the support section and download the manual by scanning the QR code or on the website of the official importer of **Könnér & Söhnen®** at **www.konner-sohnen.com**



*Please, read this manual
carefully before use!*

The manufacturer of **Könnér & Söhnen®** products reserves the right to make changes that may not be reflected in this manual, namely:

- The manufacturer reserves the right to make changes in the product design, configuration and construction.
- The images and drawings in this manual are for reference only and may differ from the actual components and inscriptions on the products.

Contact information that you are free to use in case of any problems can be found at the end of this manual. All information in this user manual is up-to-date as of the time of publication. The current list of service centers can be found on the official importer's website at **www.konner-sohnen.com**



ATTENTION – DANGER!



Failure to follow the recommendations marked with this sign may lead to serious injury or death of the operator or third parties.



IMPORTANT!



Useful information while operating the machine.

ABOUT THE UNIT

1

This chainsaw is designed for cutting branches, trunks, logs and beams of a diameter determined by the cutting length of the guide bar. It is only designed to cut wood.

IMPORTANT SAFETY INFORMATION

2

GENERAL POWER TOOL SAFETY WARNINGS



WARNING!



Failure to follow these instructions may result in damage to the product, other materials, or the surrounding area.

WORK AREA SAFETY

- Keep work area clean and well lit. Clutter or darkness in the work area can cause accidents.
- Do not operate power tools in explosive atmospheres, such as in the presence of flammable liquids, gases or dust. Power tools create sparks, which may ignite the dust or fumes.
- Keep children and bystanders away while operating the power tool. Distractions can lead to loss of control over the tool.

ELECTRICAL SAFETY

- Avoid body contact with grounded surfaces such as pipes, radiators, stoves, and refrigerators. Contact with grounded surfaces increases the risk of electric shock.
- Do not expose power tools to rain or wet conditions. Water entering a power tool will increase the risk of electric shock.

PERSONAL SAFETY

- Stay alert, watch what you are doing, and use common sense when operating the power tool. Do not use the power tool while you are tired or under the influence of drugs, alcohol or medication. A moment of inattention while operating power tools may result in serious personal injury.
- Use personal protective equipment. Always wear eye protection. Protective equipment such as a dust mask, non-skid safety shoes, hard hat or hearing protection used for appropriate conditions will reduce personal injuries.
- Prevent unintentional starting. Ensure the switch is in the off-position before connecting to a power source and/or battery pack, picking up or carrying the tool. Carrying power tools with your finger on the switch or energizing power tools that have the switch on increases the risk of accidents.
- Remove any adjusting key or wrench before turning the power tool on. A wrench or a key left attached to a rotating part of the power tool may result in personal injury.
- Do not overexert yourself. Always maintain your balance. This enables better control of the power tool in unexpected situations.
- Dress appropriately. Do not wear loose clothing or jewellery. Keep your hair, clothing, and gloves away from moving parts. Loose clothes, jewellery or long hair can be caught in moving parts.

POWER TOOL USE AND CARE

- Do not force the power tool to work beyond its limits. Use the appropriate tool for your task. A properly selected tool works more efficiently and safely within the limits it was designed for.
- Do not use the power tool if the switch does not turn it on and off. Any power tool that cannot be controlled with the switch is dangerous and must be repaired.
- Disconnect the plug from the power source and/or the battery pack from the power tool before making any adjustments, changing accessories, or storing power tools. Such preventive safety measures reduce the risk of starting the power tool accidentally.
- Store idle power tools out of the reach of children, and do not allow persons unfamiliar with the power tool or these instructions to operate the power tool. Power tools are dangerous in the hands of untrained users.
- Maintain power tools. Check for misalignment or binding of moving parts, breakage of parts and any other condition that may affect the power tool's operation. If damaged, have the power tool repaired before use. Many accidents are caused by poorly maintained power tools.
- Keep cutting tools sharp and clean. Properly maintained cutting tools with sharp cutting edges are less likely to bind and are easier to control.
- Use the power tool, accessories and tool bits etc. in accordance with these instructions, taking into account the working conditions and the work to be performed. Use of the power tool for operations different from those intended could result in a hazardous situation.
- Keep handles and gripping surfaces dry, clean and free from oil and grease. Slippery handles and gripping surfaces make it difficult to safely control the tool in unexpected situations.

BATTERY TOOL USE AND CARE

- Recharge only with the charger specified by the manufacturer. A charger that is suitable for one type of battery pack may create a risk of fire when used with another battery pack.
- Use power tools only with specifically designated battery packs. Use of any other battery packs may create a risk of injury and fire.
- When the battery pack is not in use, keep it away from other metal objects, like paper clips, coins, keys, nails, screws or other small metal objects, that can make a connection from one terminal to another. Shorting the battery terminals together may cause burns or a fire.
- Do not use damaged or modified battery packs or tools. Damaged or modified batteries may behave unpredictably, which can lead to fire, explosion, or injury.
- Follow all charging instructions and do not charge the battery pack or tool outside the temperature range specified in the instructions. Charging improperly or at temperatures outside the specified range may damage the battery and increase the risk of fire.

SERVICE

- Have your power tool serviced by a qualified repair person using only identical replacement parts. This will ensure that the safety of the power tool is maintained.
- Never service damaged battery packs. Service of battery packs should only be performed by the manufacturer or authorized service providers.

SAFETY INSTRUCTIONS FOR CHAIN SAWS

3



WARNING!



Do not operate your chain saw until it is completely assembled and installed according to the instructions.



ATTENTION – DANGER!



Keep hands away from blade. Contact with blade will result in serious personal injury.

- The cordless chainsaw is designed exclusively for cutting wood and should not be used for any non-wood items, such as brickwork, plastic, or food. Using the saw for any purpose other than sawing wood is not recommended and goes against its intended use
- Make sure that the area in which you are cutting is free from obstructions. Do not let the nose of the Guide bar contact a log, branch, fence, or any other obstruction while you are operating the unit.
- Do not grasp the exposed cutting blades or cutting edges when picking up or holding the product.
- Cut only when visibility and light are adequate for you to see clearly.
- To protect yourself from electrocution, do not operate within 50 feet of overhead electrical lines.
- Before starting the motor, make sure the chain is not contacting any object.
- Turn off the motor and make sure cutting attachment has stopped before setting unit down.
- Follow the sharpening and maintenance instructions for the saw chain.
- Use only the replacement guide bars and low kickback chains specified for the unit.
- Do not operate the saw with one hand! Serious injury to the operator, helpers, bystanders, or any combination of these persons may result from one hand operation. This saw is intended for two-hand use.
- Use extreme caution when cutting small-sized brush and saplings because slender material may catch the saw chain and be whipped toward you or pull you off balance.
- When cutting a limb that is under tension, be alert for spring back so that you will not be struck.
- To avoid accidental starting, never carry plugged in product with finger on switch.
- Maintain product with care. Keep cutting edge sharp and clean for best performance and to reduce the risk of injury. Follow this instruction for lubricating and changing accessories. Keep handles dry, clean, and free from oil and grease.
- Remove the battery pack when not in use, before servicing, and when changing accessories.
- Service on the product must be performed by qualified repair personal only. Service or maintenance performed by unqualified personal could result in injury to the user or damage to the product.

CAUSES AND OPERATOR PREVENTION OF KICKBACK

4



ATTENTION – DANGER!



Beware of kickback! Be careful of kickback of the machine during work. There is danger of injury here. You can avoid kickbacks by exercising caution and using a correct sawing technique.

- Kickback may occur when the nose or tip of the guide bar touches an object, or when the wood closes in and pinches the saw chain in the cut (cf. image 1/fig. B).

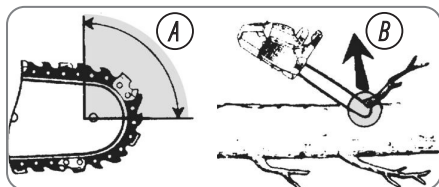

Fig. 1

- Tip contact in some cases may cause a sudden reverse reaction, kicking the guide bar up and back towards the operator (cf. image 1/fig. A).
- Pinching the saw chain along the top of the guide bar may push the guide bar rapidly back towards the operator.
- Either of these reactions may cause you to lose control of the saw which could result in serious personal injury. Do not rely exclusively upon the safety devices built into your saw. As a chain saw user, you should take several steps to keep your cutting jobs free from accident or injury.

Kickback is the result of tool misuse and/or incorrect operating procedures or conditions and can be avoided by taking proper precautions as given below:

- Maintain a firm grip, with thumbs and fingers encircling the chainsaw handles, with both hands on the saw and position your body and arm to allow you to resist kickback forces. Kickback forces can be controlled by the operator if proper precautions are taken. Do not let go of the chainsaw
- Do not overreach and do not cut above shoulder height. This helps prevent unintended tip contact and enables better control of the chainsaw in unexpected situations.
- Only use replacement bars and chains specified by the manufacturer. Incorrect replacement bars and chains may cause chain breakage and/or kickback.
- Follow the manufacturer's sharpening and maintenance instructions for the saw chain. Decreasing the depth gauge height can lead to increased kickback.







FURTHER SAFETY DIRECTIONS

5

- Comply carefully with maintenance, control and service instructions in this manual. Damaged protective devices and parts have to be repaired or changed except as noted otherwise in this manual.
- Dirt, stones, loose bark, nails, clips, and wires must be removed from the tree.

SYMBOLS

6

	Read all safety warnings and all instructions. Failure to follow the warnings and instructions may result in electric shock, fire and/or serious injury.
	Wear personal protective equipment. Basically, wear protective goggles or, even better, face protection, ear protection, safety helmet, cut-protection working clothes, cut-protection safety boots with anti-slip soles.
	Direct current-Type or characteristic of current.
	Do not use the machine in the rain or leave it outdoors when it is raining.
	Do not cut with the tip of guide.
	Hold the saw with both hands while working! One-handed use is extremely hazardous!

	<p>CAUTION: Kickback!</p>
	<p>This power tool complies with applicable European directives.</p>
	<p>Electrical appliances must not be disposed of with the domestic waste.</p>

MAIN OVERVIEW

7

1. Guide bar cover
2. Front handle guard/chain brake
3. Lock off button ring
4. Trigger
5. Oil inspection window
6. Oil tank cap
8. Guide bar
7. Saw chain
9. Rear handle
10. Toothed stop
11. Chain tensioning ring brake handle
12. Chain cover retainer
13. Chain cover

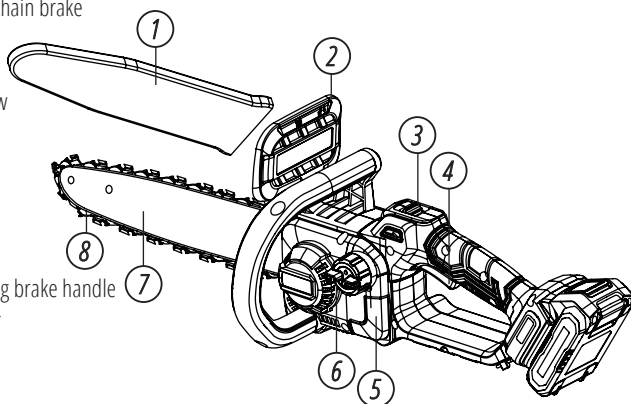

PACKAGE CONTENT LIST

- 20V Lithium Battery
- Charger for 20V Lithium Battery (for model KS MCS20V-12 Set)
- Guide bar 12" (30 cm) – 2 pcs (for model KS MCS20V-12 Set)
- Saw chain – 2 pcs (for model KS MCS20V-12 Set)

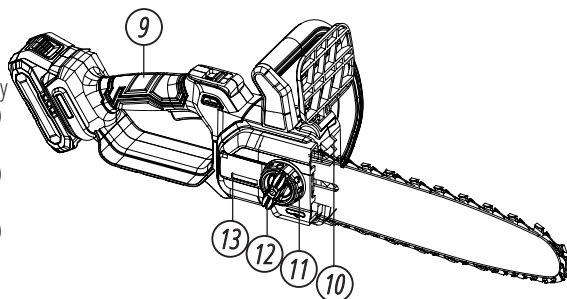

IMPORTANT!



The manufacturer reserves the right to make changes and/or improvements to the design, components, and technical specifications without notice or incurring obligation. The pictures in this manual are schematic and may not match the parameters of original product.

Model	KS MCS20V-12	KS MCS20V-12 Set
Rated voltage	DC 20V	DC 20V
Battery and charger	not included	+
Max cuttng length	200 mm	200 mm
Chain length	12" (30 cm)	12" (30 cm)
Chain pitch	1/4"LP, 0.043"	1/4"LP, 0.043"
Motor type	Brushless motor	Brushless motor
Chain speed	10 m/s	10 m/s
Oil tank capacity	40 ml	40 ml
Chain tensioning without a tool	+	+
Gross dimensions (L×W×H)	360×210×225 mm	360×210×225 mm

ASSEMBLE THE GUIDE BAR AND THE CHAIN

9



WARNING!



If the chain saw is already connected to the battery pack, remove the battery pack from the chain saw. Wear protective gloves whenever doing any work on the saw chain.

Before assembling the guide bar with the saw chain, check the cutting direction of the teeth! The running direction is marked with an arrow on the cover. To determine the direction of cut, it may be necessary to turn over the saw chain. Hold the guide bar vertically with the tip pointing upwards and put on the saw chain, beginning at the tip of the bar.

1. Loosen the chain cover by turning the chain cover knob counterclockwise (fig. 1).
2. Remove the chain cover (fig. 2).
3. Put the chain drive links into the bar groove (fig. 3).
4. Put the chain cutters in the direction of the chain operation (fig. 3).
5. Put the chain in position and make sure that the loop is behind the guide bar.
6. Hold the chain and bar.
7. Put the chain loop around the sprocket (fig. 5).
8. Make sure the chain tension pin hole on the guide bar fits correctly with the bolt.
9. Install the chain cover.
10. Tighten the chain. Refer to adjust the chain tension (fig. 5).
11. Tighten the chain cover knob when the chain is correctly tensioned.



NOTE



If you start the chain saw with a new chain, have a test for 2-3 minutes. A new chain gets longer after the first use, examine the tension and tighten the chain if necessary.

Fig. 1

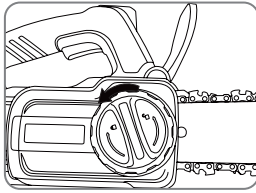

Fig. 4

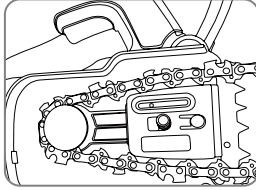

Fig. 2

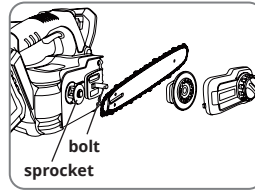

Fig. 5

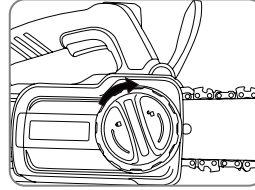

Fig. 3

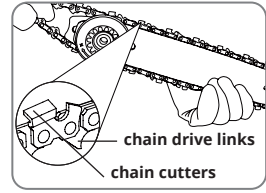
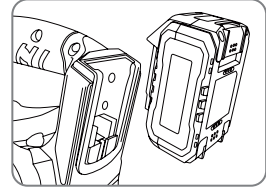

Fig. 6



INSTALL THE BATTERY PACK (Fig. 7)

- Store the battery pack fully charged.
- Do not store the battery pack on the tool.

TO REMOVE THE BATTERY PACK

Press the battery release button, slide the battery pack backward, and then pull or lift the battery out of the tool.

TO INSTALL THE BATTERY PACK

To install the battery pack into the saw, align the rails of the battery pack with the rails in the handle and push the battery into the handle. To connect the battery, slide the battery pack fully forward. Until the latch locks into place.

Follow these instructions in order to avoid injury and to reduce the risk of electric shock or fire:

- Replace the battery pack or the charger immediately if the battery case or charger cord is damaged.
- Verify that the battery pack is removed before inspecting, adjusting, or performing maintenance on any part of the chain saw.



NOTE



The charger and battery pack can be left connected with the green LED glowing indefinitely. The charger will keep the battery pack fresh and fully charged.

ADDING AND CHECK BAR AND CHAIN LUBRICANT

10

CHAIN LUBRICATION

To prevent excessive wear, the saw chain and guide bar must be evenly lubricated during operation. Lubrication is automatic. Never work without chain lubrication. It is therefore important to check both chain lubrication and the oil gauge every use (Fig. 4). Never use the saw when the oil level is below the "Min." mark. (about 5 ml of oil l left). Top up with oil until the oil window is full.

1. Loosen and remove the cap from the oil tank.
2. Put the oil into the oil tank.
3. Monitor the oil indicator to make sure that no dirt gets into the oil tank while you add the oil.
4. Put the oil cap on.
5. Tighten the oil cap.
6. The whole oil tank will last for approximately 20-40 minutes.



WARNING!



Do not use dirty, used or contaminated oil. Damage can occur to the bar or chain.

CHECKING THE AUTOMATIC

Before work, check the automatic chain lubrication and oil gauge. Switch on the chain saw and hold it above the ground. Be careful not to allow the chain saw to touch the ground. For safety reasons it is best to keep a clearance of at least 20 cm. If you now see growing traces of oil, the chain lubrication system is working correctly. If no oil trace can be seen clean the oil passages or turn the chainsaw to our Service-Center.

CHAIN LUBRICANTS

The service life depends to a large extent on the quality of the lubricant used. Old oil must not be used! To lubricate the cutting part of the saw, it is necessary to use only special adhesive oil for saw chains. Adhesive oil has increased adhesion to metal and lubricates not only the upper part of the saw bar but also the lower part.

STARTING THE CHAIN SAW

11

- Install the bar and chain (see page "Assemble the guide bar and the chain")
- Switch on the chainsaw only when chain bar, saw chain and sprocket chain wheel covering are correctly assembled.
- Make sure you have a secure stance.
- Insert the battery pack.
- Examine the oil level of the machine from the oil indicator. Add oil if necessary.
- Make sure that there are no obstructions in contact with the guide bar and the chain.
- Pull the brake baffle toward the battery pack and ensure that it remains in the working position (see fig.)
- Hold the front handle with you left hand, and hold the rear handle with your right hand.
- Push forward the lock-off button and hold the trigger switch so that the chain saw is started.

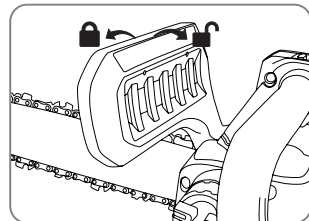

ATTENTION – DANGER!



The chain brake must be disengaged for the chain saw to start. Activate the brake by moving the front hand guard forwards.

STOPPING THE CHAIN SAW

- Remove the chain saw from the cutting area, release the trigger switch and stop the chain saw.
- Release the trigger to stop the machine.
- Push the brake baffle forward to switch it to the braking position.



ATTENTION – DANGER!



The tool runs for approximately 4 seconds after it has been switched off. Let the motor come to a complete standstill before setting the tool down.

PROPER GRIP ON HANDLES

- Wear non-slip gloves for maximum grip and protection.
- With the saw on a firm, flat surface, hold the saw firmly with both hands.
- Always grasp the front handle with the left hand and the rear handle with the right hand.
- The fingers should encircle the handle, with the thumb wrapped under the front handle.

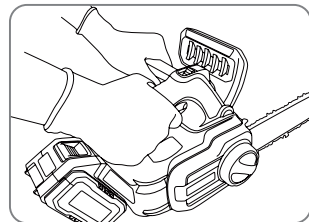



ATTENTION – DANGER!



To avoid possible serious injury, never touch or adjust the chain while the motor is running. The saw chain is very sharp, always wear protective gloves when performing maintenance to the chain.

Regularly tightening the saw chain provides safety for the user and reduces and/or prevents wear and chain damages. Before the start of work and in approx. 10-minute intervals, we recommend the user to examine the chain tension and correct it, if necessary. The chain warms up when working with the saw and thus expands slightly. These “expansions” can be expected especially from newer chains.



WARNING!



Do not re-tighten or change the chain when it is hot because it shrinks slightly once it has cooled down. In case of non-observance, this can lead to damages on the guide rail or the engine because now the chain is too taut on the blade. Chain tension and chain lubrication have a significant impact on the service life of the chain.

The chain is correctly tensioned if it does not sag at the rail underside and can be rotated completely around with the gloved hand.

OPERATION - TIPS ON CHAIN SAW USE

13

If possible, always use a saw horse.

You have better control when you saw with the bottom side of the chain bar (with pulling saw chain) and not to with the top side of the chain bar (with pushing saw chain).

The saw chain must not contact either the ground or another object during sawing through or after sawing completion.

Make sure that the saw chain does not become jammed in the wood. Do not let the tree trunk break or split off.

Consider also the precautions against kick-back (see notes on safety).

For sawing work on hillsides, always stand in the area above the log.

To keep total control while sawing through, reduce the pressure at the end of the cut without loosening your grip on the handles of the electric chain saw. Make sure the saw chain does not touch the ground. After finishing the cut, wait until the electric chain saw comes to a halt before removing it. Always shut off the engine of the electric chain saw before moving between trees.

If the saw chain jams, do not attempt to pull the electric chainsaw out with force. There is a risk of injury. Switch off the motor and use a lever or wedge to release the electric chainsaw.

Pay attention to falling branches and do not stumble.

Limbing

Many accidents occur during the removal of branches. Never cut tree limbs when you are standing on the log. Keep the spring-back area in mind if branches are under tension.

- Do not remove support branches until after the sawing off.
- Branches under tension must be sawed from below to above, in order to prevent jamming of the chainsaw.
- When working on thicker branches, use the same technique as when you are sawing up a felled trunk. Work to the left of the log and as near as possible to the chainsaw. As far as possible, the weight of the saw should rest on the log.
- Change position to saw off branches on the other side of the trunk.
- Branches sticking out are cut off separately.
- Cut off smaller branches, as shown in Figure, in one go.

Machine part	Action	Before every use	After 10 hours of operation
Components of the chain brake	Check, replace if required	✓	
Sprocket chain wheel	Check for wear/indentations, replace if necessary	✓	
Saw chain	Check oil, regrind or replace if required	✓	
Guide bar	Check, clean and oil	✓	
	Turn around		✓
Automatic oil system	Check, clean oil aperture if necessary	✓	

SHARPENING THE SAW CHAIN

15



ATTENTION – DANGER!



A properly sharpened saw chain is crucial to minimize kickback danger. Always wear cut-protection gloves when handling the chain or chain bar.



NOTE



A sharp chain provides efficient cutting, slicing through wood easily, producing large, long chips. A blunt chain requires a strong pressure on the saw, which may cause the engine overload.

The chain's cutting parts include a cutting tooth and a depth gauge. The vertical distance between these components defines the cutting depth. Keep in mind the following specifications when sharpening the cutting teeth:

- Top-plate cutting angle (30°)
- Side-plate angle (85°)
- Depth gauge setting (0.65 mm)



ATTENTION – DANGER!



Deviating from the specified cutting geometry increases kickback risk.

Sharpening the saw chain requires expertise and specific tools to maintain correct angles and depth. Follow the instructions for sharpening chain. For those inexperienced with chainsaw maintenance, it's advisable to have the chain sharpened or replaced by a professional.

1. Turn off the saw and disconnect the battery.
2. Use a 4.0 mm round file for sharpening.



WARNING!



Using other diameters can damage the chain and increase operational risks!

4. Always file from the inside out, guiding the file from the inside of the tooth outward and lifting the file on the return stroke (fig. 8).
5. Start by sharpening the teeth on one side, then turn the saw to sharpen the other side.
6. Post-sharpening, all cutting elements should be uniform in length.
7. Every third sharpening, check and file the depth gauge to maintain the correct setting of 0.65 mm below the cutting tooth, rounding off the front edge slightly after adjustment (fig. 9).

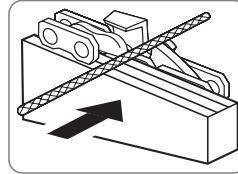

Fig. 8

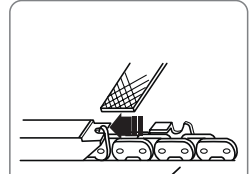
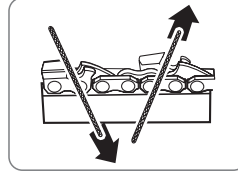

Fig. 9

GUIDE BAR MAINTENANCE

16

When the guide bar shows signs of wear, regularly approximately after 10 hours working time reverse it on the saw to distribute the wear for maximum bar life. The bar should be cleaned every day of use and checked for wear and damage.

Feathering or burring of the bar rails is a normal process of bar wear. Such faults should be smoothed with a file as soon as they occur.

A bar with any of the following faults should be replaced:

- Wear inside the bar rails which permits the chain to lay over sideways. Bent guide bar.
- Cracked or broken rails.
- Spread rails.

Lubricate guide bars with a sprocket at their tip weekly. Using a grease syringe, lubricate weekly in the lubricating hole. Turn the guide bar and check that the lubrication holes and chain groove are free from impurities.

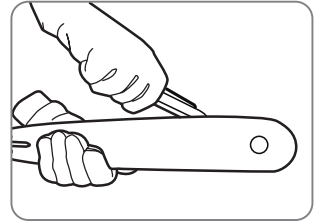
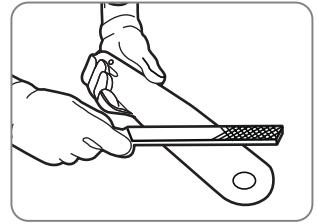

TRANSPORTATION AND STORAGE

17

Before you move the machine, always:

- Remove the battery pack from the machine.
- Keep hands clear of the lock-out button.
- Put the scabbard on the guide bar and the chain.

Before you put the machine into storage, always:

- Remove all residual oil from the machine.
- Remove the battery pack from the machine.
- Clean all unwanted material from the machine.
- Make sure that the storage area is not available to children.
- Away from agents which can cause corrosion, such as garden chemicals and de-icing salts.

DISPOSAL

18



Do not throw it in the domestic waste but dispose of it in an environmentally safe way, in accordance with current law.

The following form lists the common operating system with problem and solutions. Please read the form carefully and follow it.

Problems	Possible causes	Solution
The guide bar and the chain become hot and release smoke	The chain is too tight.	Adjust the chain tension.
	The oil tank is empty.	Add lubricants.
	Contamination causes a block-age of the discharge port.	Remove the guide bar and clean the discharge port.
	Contamination causes a block-age of the oil tank.	Clean the oil tank. Add new lubricant.
Motor runs, but chain does not rotate	The chain is too tight.	Adjust the chain tension.
	The guide bar and the chain are damaged.	Replace the guide bar and the chain if it is necessary.
	The motor is damaged.	1. Remove the battery pack from the machine. 2. Remove the guide bar cover. 3. Remove the bar and saw chain. 4. Clean the machine. 5. Install battery pack and operate the machine. If the sprocket rotates, it means the motor works properly. If not, call service center.
	The chain is in the incorrect direction.	Turn the chain loop to the other direction.
The machine does not start	The chain brake is engaged.	Pull the chain brake in the direction of the user to disengage it.
	The machine and battery are not connected correctly.	Make sure that the battery release button clicks when you install the battery pack.
	The battery level is low.	Charge the battery pack.
	The lock out button and the trigger are not pushed at the same time.	1. Push the lock-out button and hold it. 2. Push the trigger to start the machine.
	The battery is too hot or too cold.	Refer to battery and charger manual.
The motor runs, but the chain does not cut correctly, or the motor stops after around 3 seconds	The machine is in the protection mode to protect the PCB.	Release the trigger and start the machine again. Do not force the machine to cut.
	The battery is not charged.	Charge the battery. Refer to the battery and charger manual for correct charging procedures.
	The chain is not lubricated.	Lubricate the chain to decrease the friction. Do not let the guide bar and the chain operate without sufficient lubricant.
	Incorrect battery storage temperature.	Cool the battery pack until it decreases to the ambient temperature.

Könnér & Söhnen warrants the original purchaser of **power tools and battery powered and electric garden tools to 2 year** limited warranty, excluding Lithium-ion batteries that come in a set. Lithium-ion batteries which come in a set with power/garden tools or sold separately are covered with it's own warranty, described below.

- The warranty for **lithium-ion batteries is 2 years**, provided the product is registered on the website of the official importer **<https://warranty.konner-sohnen.com>** within 30 days of purchase. Without registration, the warranty is 1 year.
- The warranty for **brushless motors is 5 years**, provided the product is registered on the official importer's website **<https://warranty.konner-sohnen.com>** within 30 days of purchase. Without registration, the warranty is 2 years.



WARRANTY
REGISTRATION

CONTACTS

Deutschland:

Hergestellt unter Lizenz und Kontrolle der DIMAX International GmbH.

Importeur und Vertreter in Deutschland:
DIMAX International GmbH Flinger Broich 203, 40235
Düsseldorf, Deutschland. Produziert in VRC.

innovationtrade8@gmail.com

www.konner-sohnen.com

European Union:

Manufactured under license and control of DIMAX International GmbH, Flinger Broich 203, 40235 Duesseldorf, Germany.

Importer and representative in Netherlands DIMAX International Poland Ltd, Południowa 8 st, 05-0830 Stara Wieś, Poland. Assembled in PRC.

innovationtrade8@gmail.com

www.konner-sohnen.com

The United Kingdom:

Innovation Trade Ltd., 63/66 Hatton Garden Fifth Floor, Suite 23, London, EC1N 8LE, info.uk@dimaxgroup.de

Technical support

support.uk@dimaxgroup.de

konner-sohnen.com.uk

France:

Fabriqué sous licence et contrôle de DIMAX International GmbH, Flinger Broich 203, 40235 Düsseldorf, Allemagne.

Importateur et représentant en France et en Belgique DIMAX International Poland Ltd, Południowa 8 st, 05-0830 Stara Wieś, Pologne. Assemblé en RPC.

innovationtrade8@gmail.com

www.konner-sohnen.fr

España:

Fabricado bajo licencia y control de DIMAX International GmbH, Flinger Broich 203, 40235 Düsseldorf, Alemania.

Importador y representante en España de DIMAX International Poland Ltd, Południowa 8 st, 05-0830 Stara Wieś, Polonia.

Ensamblado en la República Popular China.

innovationtrade8@gmail.com

www.konner-sohnen.es

Polska:

Wyprodukowano na licencji i pod kontrolą DIMAX International GmbH, Flinger Broich 203, 40235 Duesseldorf, Niemcy.

Importer i przedstawiciel w Polsce:
DIMAX International Poland Sp.z o. o. ul. Południowa 8, 05-0830 Stara Wieś, Polska. Zmontowany w CRL.

innovationtrade8@gmail.com

www.konner-sohnen.pl

Україна:

Виготовлено за ліцензією та під контролем DIMAX International GmbH, Flinger Broich 203, 40235 Дюссельдорф, Німеччина.

Імпортер та представник в Україні:
ТОВ "ТЕХНО ТРЕЙД КС" вул. Електротехнічна 47, 02232, м. Київ, Україна. Змонтовано в КНР

www.konner-sohnen.com.ua