

Please read this manual carefully
before use!

User Manual



Diesel inverter generator in soundproof housing

KS 6500iDE S ATSR

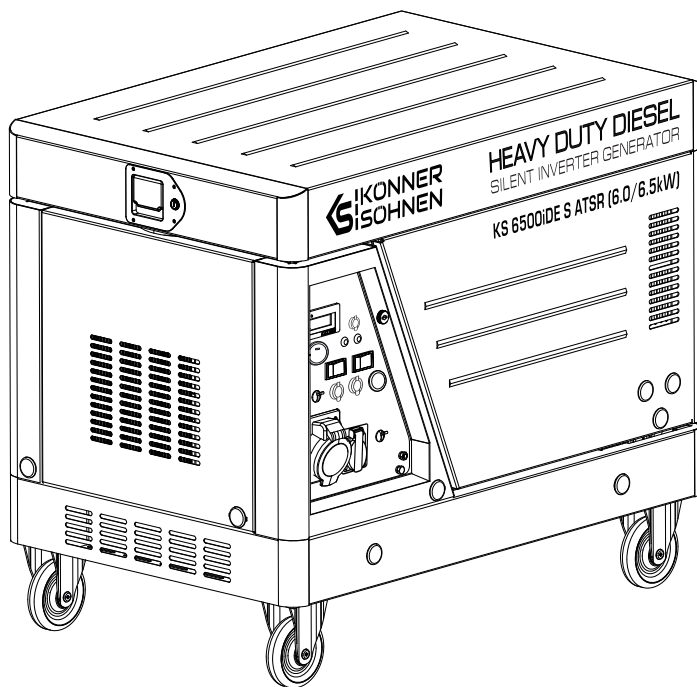



Thank you for choosing **Könnér & Söhnen®** products. This manual contains a brief description of safety, setup and use. More information can be found on the official importer's website in the support section: **konner-sohnen.com/pages/instructions**

You can also go to the support section and download the manual by scanning the QR code or on the website of the official importer of **Könnér & Söhnen®** at **www.konner-sohnen.com**



Please, read this manual carefully before use!

The manufacturer of **Könnér & Söhnen®** products reserves the right to make changes that may not be reflected in this manual, namely:

- The manufacturer reserves the right to make changes in the product design, configuration and construction.
- The images and drawings in this manual are for reference only and may differ from the actual components and inscriptions on the products.

Contact information that you are free to use in case of any problems can be found at the end of this manual. All information in this user manual is up-to-date as of the time of publication. The current list of service centers can be found on the official importer's website at **www.konner-sohnen.com**



ATTENTION – DANGER!



Failure to follow the recommendations marked with this sign may lead to serious injury or death of the operator or third parties.



IMPORTANT!



Useful information while operating the machine.

SAFETY INFORMATION

1



IMPORTANT!



Carefully read this manual before starting to work with the generator

WORKING AREA

- Please don't use the generator near flammable gases, liquids or dust. When using the generator exhaust system gets very hot. This may cause fire or explosion of these materials.
- Be sure to follow cleanliness and good lighting in the work area. Clutter and poor lighting may cause an injury.
- Do not let the presence of unauthorized persons, children or animals when working with generator. If necessary, make sure to fencing the working area.

ELECTRICAL SAFETY

- The generator produces electricity that may lead to an electric shock while neglecting compliance regulations.
- In the high humidity level conditions generator exploit is prohibited. Keep the generator in a dry place only.
- Avoid direct contact with grounded surfaces (pipes, radiators, etc.).
- Be careful when working with power cables. Immediately replace it in case of damage, as damaged wire increases the risk of electric shock.
- All connecting the generator to the network must be made by certified electrician in accordance with all electrical rules and regulations.

- The grounding of the generator and additional protective measures must be implemented depending on the power system (IT, TN, etc.). The generator is built as an IT system with isolated active conductors.
- Do not connect or disconnect a generator to electricity consumers, which are placed in water on a wet or damp soil.
- Do not touch parts of the generator under voltage.
- Connect the generator to those customers only which meet the electrical characteristics and the rated power of the generator.
- Store all electrical equipment dry and clean. Wires with damaged or spoiled insulation should be replaced. You should also replace worn, damaged or rusty contacts.

PERSONAL SAFETY

- Be careful. Do not operate the generator, if you are tired, under the influence of drugs or alcohol. Inattention may cause a serious injury.
- Avoid inadvertent start. Make sure to set the switch to Off when you turn off the generator.
- Make sure no outsider objects are on the generator when it is turned on.
- Always keep a stable position and balance when starting the generator.
- Do not overload the generator, use it only for the purpose.
- As exhaust gases contain poisonous carbon dioxide (CO₂) and carbon monoxide (CO) gases which are dangerous for life, it is strictly forbidden to install the generator in residential buildings, premises connected to residential buildings by a common ventilation system, other rooms from which exhaust gases may enter living premises.

OPERATING AND MAINTAINING THE GENERATOR

- Before you start checks before operating, make sure that the generator is on a flat level surface and the engine switch is set to OFF.
- Check the connection of moving parts, no damaged parts that affect the operation of the generator. If the generator is damaged, remove them before using.
- For repair and maintenance use only recommended oil fuel. Using other lubricants, spare parts and consumables deprives you of warranty apparatus.
- Servicing the generator should be carried out only by qualified personnel. The current list of service centers you can find at the website of official importer: **www.konner-sohnen.com**
- Keep the generator dry, well ventilated place if you are not using it.



ATTENTION - DANGER!



The generator runs on automotive diesel fuel and conform to European quality standards not lower than Euro 5 emission standard. The generator runs on automotive diesel fuel. Do not use gasoline, kerosene, fuel oil as fuel. Diesel fuel type should correspond the operating season.

The use of low-grade fuel can lead to a degradation of the manufacturer's declared specifications or to engine failure. Do not add any chemical additives to diesel fuel and do not mix diesel fuel with used engine oil or fuel oil.

Keep the fuel tank and refueling accessories clean and neat and ensure that no foreign objects / debris get into the fuel tank when refueling the generator. Sulfur content should not exceed 0.5% (less than 0.05% is recommended). Sediment and water content in fuel should not exceed 0.05%. A cetane number of at least 45 must be ensured. For example, biodiesel fuel which is known under the B5 brand, is permitted. This type fuel should contain no more than 5% of fatty acid methyl esters (FAME) and 95% of mineral diesel fuel. Read more about the requirements for biodiesel in the full web version: **konner-sohnen.com/pages/instructions**

Diesel fuel characteristics	Region of use
EN590:96	European Union
BS 2869-A1 or A2	Great Britain

SAFETY SYMBOLS. DESCRIPTION OF SAFETY SYMBOLS WHEN OPERATING THE GENERATOR

2

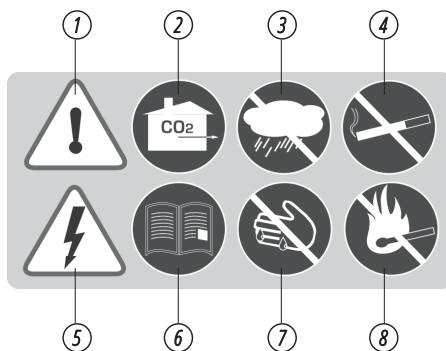

1. Be careful when operating the device! Observe the safety instructions in this manual.
2. Operate the generator only in well-ventilated indoor spaces or outdoors. Exhaust gases contain CO₂, whose vapors are life threatening.
3. Do not operate or store the device in highhumidity environments.
4. Do not smoke while operating the generator!
5. The device generates electricity. Observe safety precautions to avoid electric shock.
6. Read this owner's manual carefully before operating the device.
7. Do not touch the generator with wet or dirty hands.
8. Observe fire safety regulations, do not operate the generator near open flame.

MAIN OVERVIEW

3

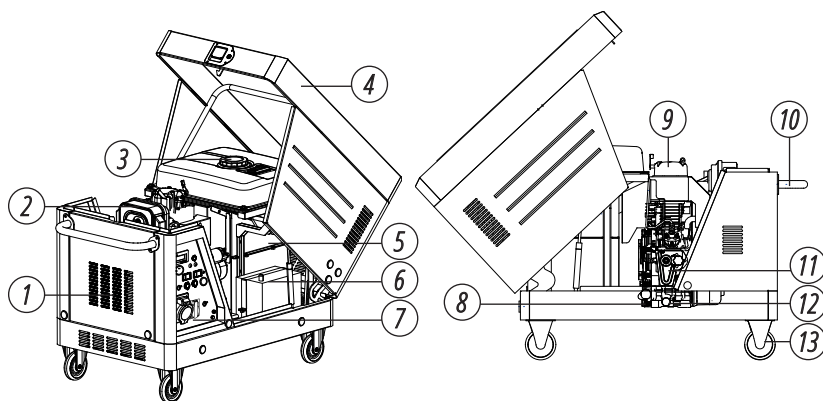

1. Chassis
2. Air filter
3. Fuel tank cap
4. Cover plate
5. Muffler guard
6. Battery
7. Control panel
8. Oil filter
9. Engine
10. Transport handle
11. Speed control handle combination switch
12. Drain bolt
13. Transportation wheels



IMPORTANT!



The manufacturer reserves the right to make changes and/or improvements to the design, components, and technical attributes without notice or obligation. The pictures in this manual are schematical and may not match the parameters of original product.

PACKAGE INCLUDE:

- Packaging
- Generator
- Owner's manual
- 14–17 fork wrench – 1pc
- 12–10 fork wrench – 1pc
- GX20 plug – 1pc
- Top cover key – 2pc
- Dual-use screwdriver – 1pc
- 230V 16A plug – 2pc
- 230V 32A plug – 1pc
- Remote control – 2pc
- Extended funnel – 1pc
- Battery charging cable – 1pc

CONTROL PANEL 4

1. ATS input
2. Circuit breakers for 230V outputs
3. Main switch
4. START/STOP button
5. Multifunctional LED-display (voltage, power, oil alarm, gasoline level, low idle, single running time, total running time, reset function after protection, frequency)
6. Oil heater
7. DC5521 battery charging socket
8. Air preheater
9. External control switch
10. Emergency stop
11. Connection for external PF control contacts
12. Earthing bolt
13. AC outlet Schuko 230V
14. AC outlet CEE 230V 32A

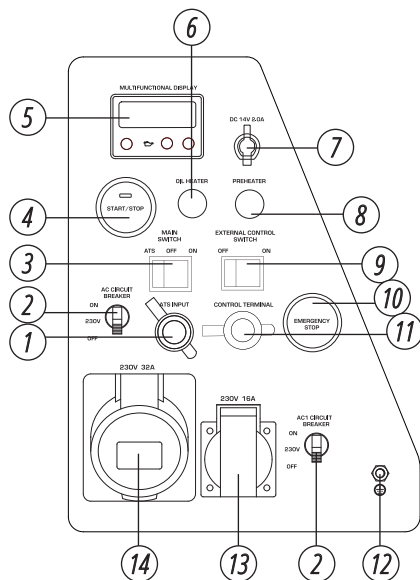

Model	KS 6500iDE S ATSR
Voltage	230 V
Max power	6,5 kW
Nominal power (cosφ = 1.0)	6,0 kW
Nominal arequency	50 Hz
Current max	28,3 A
Outlets	1 × Schuko 230V 16A, 1 × CEE 230V 32A
Fuel tank volume	25 l
Fuel consumption at 50% load*	1,2 l/h
Multifunctional LED-display	voltage, power, oil alarm, gasoline level, low idle, single running time, total running time, reset function after protection, frequency
Noise level (Lwa)	69/97 dB
Connection for external charger	DC5521
Engine model	KS 520iD
Engine type	diesel powered one-cylinder, four-stroke air-cooled
Engine power	8,5 kW/11,5 hp
Crank case volume	1,65 l
Engine cylinder volume	498 cm ³
Preheater	+
Engine start	manual/electric/remote
Frame diameter	soundproof housing
Battery	Lead-acid battery 12V 36Ah
Output for ATS	+
Dimensions (generator + carton + pallet), L×W×H	870×580×765 mm
Generator net weight/ Generator + carton + pallet weight	119/139 kg
Protection class	IP23
Altitude (MAX)	1000 m
Acceptable deviation of a current is 10%	

*Fuel consumption depends on many factors, such as load, fuel quality, season, altitude, technical condition of the generator.

The sound power level (**LWA**) indicates the noise level directly at the noise source.

The optimum operating conditions are ambient temperature of 17°C – 25°C, barometric pressure of 0,1 MPa (760 mm Hg), and relative humidity of 50 – 60%. Under such ambient conditions, the generator can guarantee maximum performance in terms of the stated specifications. In case of deviations from the above ambient values, the performance of the generator can be different.

Please note that in order to preserve the lifespan of the generator, continuous loads should not exceed 80% of the rated power.

When starting operating the generator, it's recommended to ground it. Before starting the unit, remember that the total power of consumers connected should not exceed the rated capacity of the generator.

TYPES OF CONSUMERS AND INRUSH CURRENT

Power consumers are divided into resistive and reactive loads. Reactive loads have a power factor below 1 and require not only active power but also reactive power, which the generator must provide.

Power consumers with motors require a starting power. This can be 2-5 times higher than the nominal power and must not exceed the generator's maximum power. Devices with a soft start based on phase-cut control require lower starting power but can significantly distort the voltage waveform, which may negatively affect other power consumers connected in parallel.

The inverter generator produces a sinusoidal voltage wave, making it suitable for electronic power consumers. However, attention must be paid to the power factor of the load, especially with chargers that lack built-in power factor correction and require a very high reactive power, which the generator must provide.

The generator produces a voltage of 230V at 50Hz and must not be connected to a feed-in system (on-grid or hybrid inverter) instead of the public power grid. Feedback power could damage the generator.

BEFORE STARTING

7

The generator is supplied without fuel. Before the operation please fill the fuel. Guidelines for filling are below. Generators are supplied without motor oil. The generator casing may contain residues of oil after tests conducted during production.

Before starting to use the generator, be sure to pour oil. Recommendations on oil and it's filling process are below. Follow maintenance recommendations during the first month or twenty hours (whichever occurs first) contained in the "Maintenance" section.

CHECK THE FUEL LEVEL

1. Remove the fuel tank cap and check the fuel level.
2. Fill fuel to the level of the fuel filter and make sure there is no air in the fuel system.
3. Screw the fuel tank cap back tightly.

CHECK THE OIL LEVEL

1. Unscrew the oil level gage and clean it with clean cloth.
2. Put the oil gage back without screwing it.
3. Take the oil level gage out and check the oil level according to the mark on a gage.
4. Add oil if it's level is below the mark on a gage.
5. Screw the oil gage back.

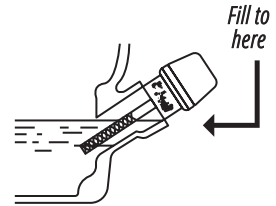

For commissioning models with elektrostart please charge the battery. Please use additional battery charger (not included) to charge the battery or let the generator work at least one hour at 50% load at the first start.



IMPORTANT!



Diesel fuel type should correspond the operating season.

STARTING TO WORK

8

Before starting the engine, make sure that the rated power of power consumers matches with the power of generator. Do not exceed the nominal power of the generator. **Do not connect the device before starting the engine!**



ATTENTION - DANGER!



The generator must not be connected in parallel with other power sources, such as an on-grid inverter, the AC input of a hybrid inverter, an AC energy storage system, or other generators.

**ATTENTION - DANGER!****Do not let the generator work more than 30 minutes in range from nominal to maximum.**

This material is for informational purposes only and is not an instruction how to install or connect equipment to the network. In practice, there are different options for supplying electricity and different rules for its connection. The decision on how to properly connect the equipment in each individual case must be made by a certified electrician who performs the installation and electrical connection of the equipment. The manufacturer is not responsible for improper connection of equipment, and is not responsible for possible material and physical damage that may occur as a result of improper installation, connection or operation of equipment.

IN THE FIRST 20 OPERATING HOURS OF THE GENERATOR, THE FOLLOWING REQUIREMENTS SHOULD BE MET:

1. During commissioning, do not connect power consumers, the power of which exceeds 50% of the nominal (operating) power of the device.
2. After the first 20 operating hours, be sure to change the oil. It is better to drain oil while the engine is still hot after operation to ensure quick and complete oil draining.
3. Check and clean the air filter and fuel filter.

ELECTRIC START

1. Check the fuel level
2. Check the oil level
3. Do not connect any load to the generator before starting the engine.
4. Connect the terminals to the battery, ensuring correct polarity ("positive to positive," "negative to negative").
5. Set the engine emergency shutdown lever (fig. 1) to the ON position, if it is in the left position.
6. Switch the EXTERNAL CONTROL button to the OFF position.
7. There is an opening on the top cover of the generator. Through this opening, press the decompression lever (fig. 2), located at the top of the cylinder head, to reduce cylinder pressure and facilitate engine starting.
8. Turn the MAIN SWITCH to the ON position, press the air preheating button for 5-10 seconds if the outside temperature is below +5°C, and then press the START/STOP button. Use the oil preheating function as needed during cold seasons.
9. If the engine does not start after pressing the START/STOP button, wait 15 seconds before attempting to start again. Prolonged use of the starting system can discharge the battery.

Fig. 1

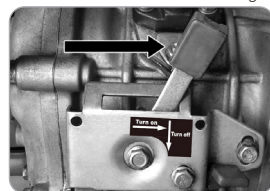

Fig. 2

**IMPORTANT!**

If engine does not start after three or four attempts, it may mean that the fuel system has some air inside. Remove the air from the fuel system (drain the diesel fuel, with the fuel there will be excess of air).

**ATTENTION - DANGER!**

Do not let the simultaneous connection of two or more devices. Start of many devices requires large power capacity

Devices are to be connected in turns, according to its maximum allowed power. Do not connect the consumers in first 1-2 minutes after the generator start. Do not stop the generator, if there are any devices connected. This may result to generator breakdown.

Before turning the generator on, verify that the connected devices are in working order.

**IMPORTANT!**

DISCONNECT ALL DEVICES BEFORE STOPPING THE GENERATOR! Do not stop the generator with the devices turned on. This may disable the generator or devices connected to it!

STARTING WITH ELECTRIC STARTER IN THE COLD SEASON

- When the air temperature is lower than +5 °C it is necessary to use the “Preheater” function when starting.
- If the outside temperature is below -5 °C, the “Oil preheating” function must be used during startup.

**IMPORTANT!**

Do not hold the button PREHEATER more than 10 seconds, it may cause the failure of incandescent candles

ENGINE SHUTDOWN PROCEDURE

1. Disconnect all devices connected to the generator.
2. Let the generator run for 3 minutes without load to cool down.
3. Press the round START/STOP button to stop the generator.
4. Turn the MAIN SWITCH to the OFF position to disconnect the control system from the power supply.
5. The mechanical emergency switch (button on the right in Fig. 1) interrupts the operation of the fuel pump and should be used as a last resort to stop the engine if stopping with the START/STOP button and turning off the MAIN SWITCH do not work. The EMERGENCY STOP button on the control panel switches off power to the generator control system and the electromagnetic fuel valve.

CONNECTING DEVICES

Do not let the generator work more than 30 minutes in range from nominal to maximum. After starting the engine, make sure the voltmeter readings correspond to the nominal (at 50 Hz 230V±10%).

STARTING THE GENERATOR USING THE ATS UNIT

To switch the generator control to an external ATS unit, set the MAIN SWITCH to the ATS position.

TECHNICAL MAINTENANCE WORKS

9

Works, specified in “Technical maintenance” section, are to be regularly performed. If the the generator user has no possibility to perform regular maintenance independently, it is necessary to address the official service center to registrate an order for such works performance.

**IMPORTANT!**

In case of any damages, occurred due to non-performance of regular maintenance works, the manufacturer bears no responsibility for such damages.

MANUAL COMPLIANCE

Technical maintenance, operation and Könnér & Söhnen® generator storage are to be performed according to this manual recommendations. Manufacturer bears no responsibility for damages and losses, caused by incomppliance to safety requirements and technical maintenance rules.

FIRST OF ALL THIS APPLIES TO:

- use of lubricants, gasoline and motor oils, forbidden by the manufacturer;
- device technical alterations;
- equipment operations against its intended use;
- indirect damages, caused by operating faulty equipment;

This manual compliance! You can find a list of service center addresses on the website of exclusive importer: **www.konner-sohnen.com**

TECHNICAL MAINTENANCE WORKS

Node	Service type	Every start	Commissioning (first 20 hours)	Each 3 months or after 50 working hrs	Each 6 months or after 100 working hrs
Motor oil	Check the level	✓			
	Replace		✓	✓	
Air filter	Check/Clean out		✓	✓	
	Replace				✓
Oil filter	Clean out		✓	✓	
Fuel tank	Check the level	✓			
	Check/Clean out		✓		✓
Fuel filter	Check/Clean out		✓	✓	
	Replace				✓

RECOMMENDED OILS

10

Motor oil has a serious impact on performance characteristics and is a major attribute, defining its service life. Use oils designed for four-stroke cycle vehicle engines SAE 10W-30, SAE 10W-40, since such oils contain cleaning additives, which comply or even exceed SE standards according to API classification (or equivalent). Motor oils with other viscosity levels, may be used only if the average air temperature in your region does not exceed the limits of the temperature range, specified in the table. Oil viscosity according to SAE standards or service category, are specified on the API capacity sticker.

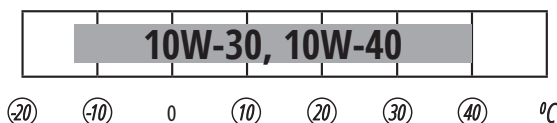

ENGINE OIL REPLACEMENT OR ADDING

Upon oil level decrease it is necessary to add the required quantity in order to provide the correct generator operation. It is necessary to check the oil levels according to technical maintenance schedule. When changing the oil, remove the oil filter, flush it with gasoline and install it back.

TO DRAIN ENGINE OIL, PERFORM THE FOLLOWING ACTIONS:

1. Drain the oil while the engine is still warm. This ensures a quick and complete oil drain.
2. Wear protective gloves to avoid oil contact with your skin.
3. Open the maintenance cover.
4. Place a drain oil holding tank under the engine.
5. Unscrew the oil drain plug using the appropriate wrench.
6. Wait till the oil drains.
7. Screw the oil drain plug back in. If necessary, use a new oil drain plug.

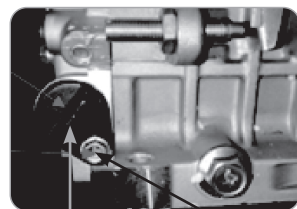
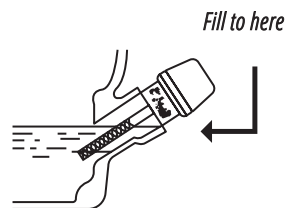

oil filter bolt



NOTE



Alternatively, the engine oil can be removed using an oil suction pump instead of draining it.

OIL FILLING:

1. Make sure that the generator is set on flat level surface.
2. Unscrew the oil gage cap on the engine.
3. By means of a funnel, pour the advanced purification engine oil to the crankcase. The funnel is not included. Oil level after filling has to be close to the upper part of oil filler.

AIR FILTER MAINTENANCE

11

It is necessary to check the air filter from time to time and clean any contaminations. Regular air filter maintenance is necessary to maintain sufficient carburetor air inflow. The air filter should be cleaned more often when using generator in dusty conditions.

Air filter cleaning is to be performed each 50 hours of the generator operation (every 10 hours in unusually dusty conditions).

1. Remove the hand nut and remove the cover of the air filter (Fig. 3).
2. Unscrew the nut and remove the filter element (Fig. 4).
3. Clean the air filter tank and cover to prevent dust and other foreign objects from entering the engine air intake.
4. The filter element should be replaced according to its pollution, or cleaned or inspected as follows:



Abb. 4



CLEAN FILTER ELEMENT:

Paper filter element: dry pollution, blown from inside to outside with compressed air until there is no dirt. Take care that the strength of the compressed air does not exceed 5 bar.

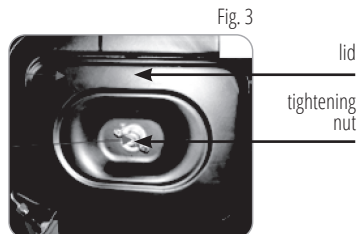
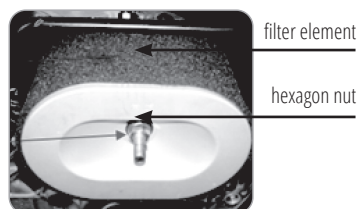
Foam filter: clean the foam filter with cleaning agent and wring out the water, add an appropriate amount of lubricating oil and squeeze out the excess oil.

REPLACE THE FILTER ELEMENT:

Wet or oily pollution must replace the paper filter element.

CHECK

1. Check whether the surface of the filter cartridge washer is damaged.
2. Make the filter element through the light source to check whether there are cracks or other damage.
3. Reassemble the filter element and cover in reverse order.

filter washer

paper filter element

foam filter element



Abb. 5



ATTENTION - DANGER!

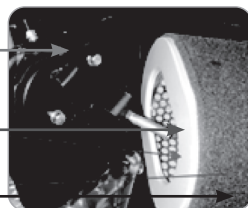

Never run the engine with the air filter removed or without the filter. Otherwise dirt and dust lead to rapid breakage of engine parts. Failure in this case will not be repaired.



IMPORTANT!



Air filter replacement is to be performed each 50-100 hours of the generator operation (every 10 hours in unusually dusty conditions).

There are two kinds of fuel filters in Könnér & Söhnen® diesel generators. They prevent the ingress of contaminants from diesel fuel to the engine.

COARSE CLEANING FUEL FILTER

Remove the filter after the possible hard particles hit every 500 operating hours. Never use water for purification the filter.

1. Remove the fuel cap.
2. Remove the fuel filter.
3. Use diesel fuel to clean the filter.
4. Put the filter back to the fuel tank.

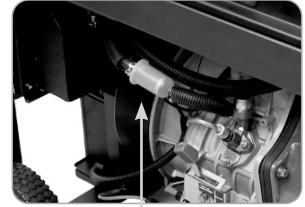

fuel filter

THE FUEL FILTER IN THE FUEL SUPPLY PIPELINE

This filter has to be replaced every 100 operating hours. It's located under the fuel tank on the fuel hose through which fuel enters the engine from the tank. To replace it:

1. Loosen the metal hose clamps, located next to the fuel valve to drain the fuel.
2. Drain the fuel to some special volume.
3. Loosen metal staples on both sides of the fuel filter.
4. Remove the filter.
5. Install new filter, paying attention to the arrow shown. The filter should be installed in the fuel passage direction.
6. Tighten the bracket on the fuel hose.



ATTENTION - DANGER!



Keep an eye on the position of the fuel filter, it should be located to the maximum upright.

1. Open the fuel tank cap and remove the fuel filter from the filling port (fig. 5).
2. Use a clean container to drain the diesel from the tank (fig. 6).
3. Place the clean container under the fuel filter, remove the fuel filter, and replace with a new fuel filter (fig. 7).
4. Use compressed air to blow out the dirt in the fuel filter, put it back into the oil filling port, inject diesel oil, and tighten the fuel tank cap. The fuel injection system will automatically drain oil.

Fig. 5

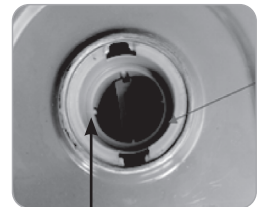

fuel filter

Fig. 6

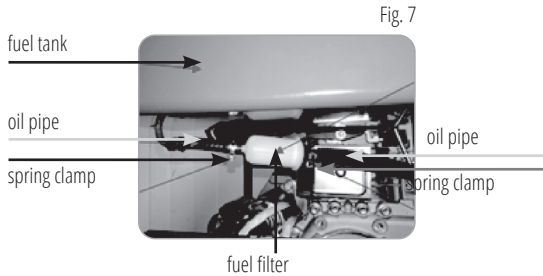
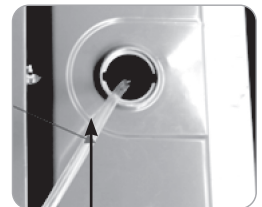

Fig. 7



tank pumping

In Könnér & Söhnen® models with electric start you should periodically perform battery voltage checks. The generator battery has a voltage of 12,7. We recommend charging the battery every three months with an external charger for lead-acid batteries to prevent battery sulfation. The battery can be charged either

directly via the terminal clamps or through the DC5521 socket on the control panel. It is recommended to use the SAE connector adapter supplied in the kit, as well as the KS B2A charger, which enables monitoring of the battery voltage.

If the generator is not used for a long time, please disconnect the battery from the terminals. The battery that comes with the generator does not require additional maintenance and filling of electrolyte.

The battery is a consumable part and may become damaged due to deep discharge or lose capacity if it is not sufficiently charged.

GENERATOR STORAGE

14

Storage room has to be dry and free from dust deposits. Storage room also has to be locked away from children.



IMPORTANT!



Warning! Generator is to remain ready for operation at all times. Therefore in case of device malfunctions, they are to be repaired before dismantling the generator for storage.

LONG-TERM STORAGE

If you do not plan to use the generator for a long time, we recommend:

- Drain the fuel from the tank.
- Drain the oil from the engine.
- Pull the manual starter until you feel light resistance so that the intake and exhaust valves are closed.
- Remove the negative terminal of the battery for the electric start models.
- Clean generator from dirt and dust.

When starting the generator after long storage, follow all procedures in reverse order.



IMPORTANT!



Pay attention to the fact that upon failed attempts to launch the generator by means of an electric start, the accumulator units may turn out de-energized, therefore prior to operation start it may be necessary to perform full accumulator unit charging.

BATTERY AND GENERATOR DISPOSAL

15

To prevent environment damage generator and battery should be separated from ordinary waste. Please recycle them in the safest way, passing it to special place for disposal.

Typical failures	Possible reason	Solution
Engine does not start	Engine starting switch set to OFF position	Set the engine starting switch to ON
	No fuel	Add fuel
	Low-quality or dirty fuel is in engine	Change the fuel
Low engine power / heavy starting	Dirt in fuel tank	Clean the fuel tank
	Air filter is dirty	Change the air filter
	Water or air in the fuel line	Pump the fuel line
Engine is overheated	Cooling fins are dirty	Clean the cooling fins
	Air filter is dirty	Change the air filter
No voltage while engine is working	Circuit breaker is active	Turn on the circuit breaker
	Connected cables are corrupted	Check the cables; if using extension cord, change it
	Plugged device failure	Try to connect other devices
Connected devices are not working while generator is running	Generator is overloaded	Unplug some devices to reduce load
	Short circuit occurred in one of the devices connected	Unplug that device to restore the stability of a system
	Air filter is dirty	Change the air filter
	Repetitions of an engine are lower than nominal	Contact the service center

Device	Average power usage
Iron	500-1100 W
Air hair dryer	450-1200 W
Coffee machine	800-1500 W
Electric cooking stove	800-1800 W
Toaster	600-1500 W
Air heater	1000-2000 W
Vacuum cleaner	400-1000 W
Radio	50-250 W
BBQ Grill electric device	1200-2300 W
Oven	1000-2000 W
Refrigerator	100-150 W
TV set	100-400 W
Hammer drill	600-1400 W
Drill	400-800 W
Freezer	100-400 W
Grinding machine	300-1100 W
Circular saw	750-1600 W
Angle grinder	650-2200 W
Electro jigsaw	250-700 W
Electro planer	400-1000 W
Compressor	750-3000 W
Water pump	750-3900 W
Electric sawing machine	1800-4000 W
Electric lawn	750-3000 W
Electric powered engines	550-5000 W
Electric fan	750-1700 W
High pressure machine	2000-4000 W
Air conditioner	1000-5000 W

The international manufacturer warranty is 1 year or 1000 hours (whichever comes first). The warranty period starts from the date of purchase. In cases when warranty period is longer than 1 year according to local legislation please contact your local dealer. The Seller which sells the product is responsible for granting the warranty. Please contact the Seller for warranty. Within the warranty period, if the product fails because of defects in the production process, it will be exchanged on the same product or repaired.

The warranty card should be kept throughout the warranty period. In case of warranty card loss, a second one will not be provided. The customer must provide the warranty card and buyer's check during request for repair or exchange. Otherwise, the warranty service will not be provided. The warranty card, attached to the product during sale, should be correctly and fully completed by the retailer and customer, signed and stamped. In other cases, warranty is not considered as valid.

Provide clean product to the service center. Parts, that must be replaced, are the property of the service center.

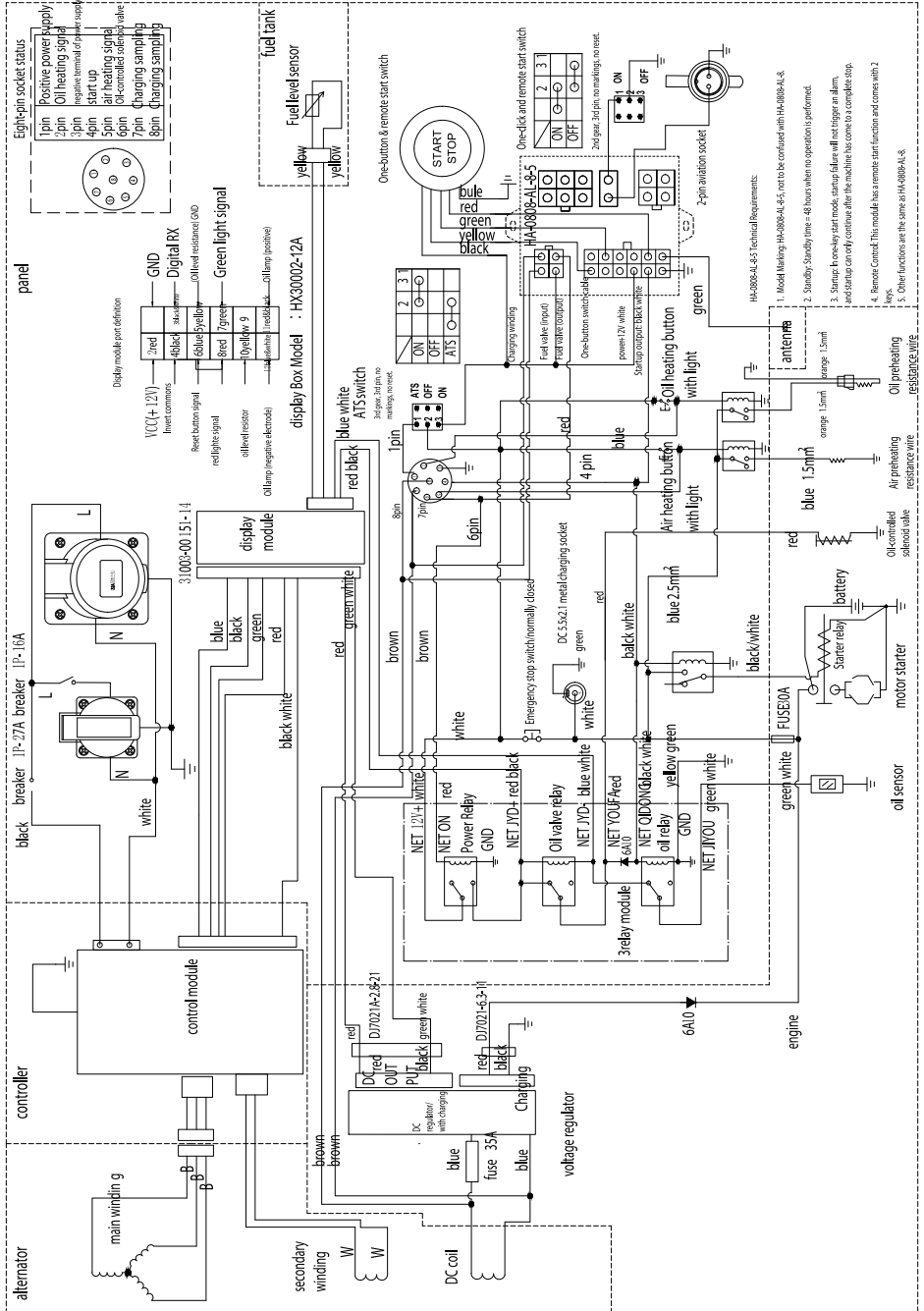

- HA808U-4.5 Technical Requirements:
1. Model Marking: HA-808U-4.5, not to be confused with HA-808U-4.8.
 2. Standby: Standby time ≤ 48 hours when no operation is performed.
 3. Startup: In one-way start mode, startup failure will not trigger an alarm. After startup on only continue after the machine has come to a complete stop.
 4. Remote Control: This module has remote start function and comes with 2 keys.
 5. Other functions are the same as HA-808U-4.8.



EC Declaration of Conformity

Nr. 225

The following products have been tested by us with the listed standards and found in compliance with the European Community Machinery Directive 2006/42/EC, Electromagnetic compatibility Directive (EMC) 2014/30/EC, Noise Directive 2000/14/EC.

Manufacturer: DIMAX INTERNATIONAL GmbH
Address: Flinger Broich 203, 40235 Duesseldorf, Germany
Product: Diesel inverter generator "Können & Söhnen"
Type / Model: KS 6500iDE S ATSR

The statement is based on a single evaluation of above mentioned products. It does not imply an assessment of the whole production and does not permit the use of the test lab. logo. The manufacturer should ensure that all product in series production are in conformity with the product sample detailed in this report. The applicant should hold the whole technical report at disposal of the competent all the right.

Applied EC Directives: 2006/42/EC Machinery Directive
2014/30/EC Electromagnetic compatibility Directive (EMC)
2000/14/EC Noise Directive
(EU) 2016/1628 Non-Road mobile machinery emissions

Applied Standards: EN ISO 8528-13:2016
EN 55012:2007 + A1:2009
EN ISO 3744:1995

Diesel engines KS 520iD correspond to European Emission Standard Euro V (STAGE V).
This is confirmed by EU TYPE-APPROVAL CERTIFICATE issued by department of transport of Madrid, Spain.
Technical service responsible for carrying out the test -IDIADA.
Date of test reports 22/11/2022

2000/14/EG_2005/88/EG Annex VI

For model KS 6500iDE S ATSR Noise measured Lwa = 94 dB (A), guaranteed Lwa = 97 dB (A)



24

Issued Date: 2025-04-01
Place of issue: Duesseldorf
Director: Fomin P.

P. Fomin

DIMAX
International GmbH
Flinger Broich 203 40235 Düsseldorf
USt-ID DE296177274
koenner-soehnen.com

We DIMAX INTERNATIONAL GmbH hereby declare that specified above conforms covering European Parliament and Council Directives, 2006/42/EC of 17 May 2006 Machinery Directive, Electromagnetic compatibility Directive (EMC) 2014/30/EC of 26 February 2014, Noise Directive 2000/14/EC of 8 May 2000. The CE mark above can be used under the responsibility of manufacturer. After completion of an EC declaration of Conformity and compliance with all relevant EC directives.

CONTACTS

Deutschland:

Hergestellt unter Lizenz und Kontrolle der DIMAX International GmbH.

Importeur und Vertreter in Deutschland:
DIMAX International GmbH, Flinger Broich 203,
40235 Düsseldorf, Deutschland. Produziert in VRC.
amazon@dimaxgroup.com
www.konner-sohnen.com

European Union:

Manufactured under license and control of DIMAX International GmbH, Flinger Broich 203, 40235 Duesseeldorf, Germany.

Importer and representative in Netherlands DIMAX International Poland Ltd, Południowa 8 st,
05-830 Stara Wieś, Poland. Assembled in PRC.
amazon@dimaxgroup.com
www.konner-sohnen.com

The United Kingdom:

Innovation Trade Ltd., 5th Floor, 167-169 Great Portland Street, London, W1W 5PF, sales.uk@dimaxgroup.com

Technical support

support.uk@dimaxgroup.de
konner-sohnen.com.uk

France:

Fabriqu e sous licence et contr ole de DIMAX International GmbH, Flinger Broich 203, 40235 D usseldorf, Allemagne.

Importateur et repr esentant en France et en Belgique
DIMAX International Poland Ltd, Południowa 8 st,
05-830 Stara Wieś, Pologne. Assembl e en RPC.
amazon@dimaxgroup.com
www.konner-sohnen.fr

España:

Fabricado bajo licencia y control de DIMAX International GmbH, Flinger Broich 203, 40235 D usseldorf, Alemania.

Importador y representante en Espa a de DIMAX International Poland Ltd, Południowa 8 st,
05-830 Stara Wieś, Polonia.
Ensamblado en la Rep blica Popular China.
amazon@dimaxgroup.com
www.konner-sohnen.es

Polska:

Wyprodukowano na licencji i pod kontrolą DIMAX International GmbH, Flinger Broich 203,
40235 Duesseeldorf, Niemcy.

Importer i przedstawiciel w Polsce:
DIMAX International Poland Sp.z o. o. ul. Południowa 8,
05-830 Stara Wieś, Polska. Zmontowany w CRL.
amazon@dimaxgroup.com
www.konner-sohnen.pl

Україна:

Виготовлено за ліцензією та під контролем DIMAX International GmbH, Flinger Broich 203,
40235 Дюссельдорф, Німеччина.

Імпортер та представник в Україні:
ТОВ "ТЕХНО ТРЕЙД КС" вул. Електротехнічна 47,
02225, м. Київ, Україна. Змонтовано в КНР
www.konner-sohnen.com.ua

